

Anticon roofing blanket

INSTALLATION GUIDE FOR RESIDENTIAL CLASS 1

Note: This Installation Guide is only applicable for use with the following products when installed in the applications included in this Installation Guide for use in Australia. Installation details shown in this guide provides general guidelines on installation only. Alternative installation methods may also be used to install these products. For applications and install details not covered in this guide, please contact your Bradford representative. Please check for the latest version at bradfordinsulation.com.au

APPLICABLE PRODUCTS

- CSR Bradford Anticon 60 and 80 faced with a Reflective Foil Laminate (RFL) membrane.
- CSR Bradford Anticon 100 faced with a RFL for specific projects where an assessment has been made to the recovery, and excessive pressure is not applied to foil or cladding.

APPLICATIONS

- Applicable to residential timber or steel framed roofs with no safety mesh, allowing product to recover in a downward direction.
- Suitable for metal roof deck or corrugated roof sheeting using no additional spacer other than suitable height battens.
- Suitable for roofs requiring water, air or vapour control layer.

GETTING STARTED

Anticon must be installed dry and remain dry until the roof is completed - this is a CSR Bradford Warranty Condition.

It is not recommended that the installation be commenced if it cannot be completed. If the installation cannot be completed prior to rain or is left exposed for a period of time, the Anticon should be protected from getting wet.

Anticon requires evenly distributed support that can be provided by battens, roof rafter, trusses, etc. The spacing of this structural support will then determine the correct type of RFL membrane required for the Anticon. Please ensure that you have the correct duty strength of RFL prior to commencing the project, refer to the Product Selection Guide.

Note: Incorrect selection of the RFL may lead to the membrane not having sufficient strength to resist excessive compression of blanket, due to lack of bulk insulation recovery between supports, which may result in tearing of the membrane.

Working on a roof can be hazardous, ensure you have appropriate safety equipment and correct footwear as well as a safe means of getting the Anticon onto the roof. If battens are covered over by product, it is more difficult to sight firm footing placement.

ITEMS REQUIRED

- Appropriate safety harness and footwear
- Hammer
- Brad-Fix clips
- Knife
- Tape

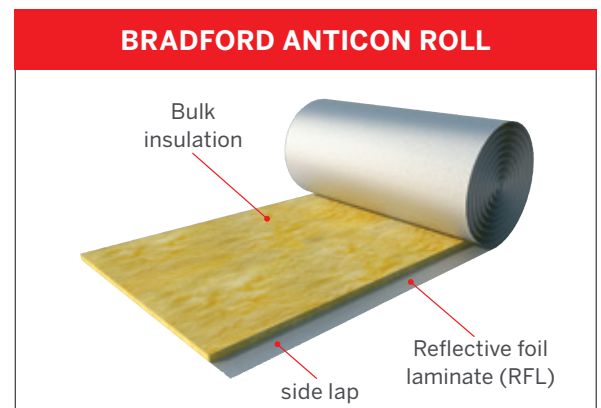

Installation

The Anticon product is installed with blanket side up and RFL facing down*, it can be installed in one of 3 methods:

1. Vertical roll out over battens – this is the preferred method of the roofing industry as it allows a synchronised installation with roof cladding material, less product is left exposed prior to cladding and it is easier to sight firm foot placement.
2. Horizontal roll out over battens
3. Horizontal roll out under battens

The following steps are applicable for METHOD 1 – VERTICAL ROLL OUT OVER BATTENS. For details on how to install with the other methods, please see the specific guide for these methods. Contact Bradford for a copy.

METHOD 1 VERTICAL ROLL OUT OVER BATTENS

STEP 1

Position the start of roll nearest to the roof ridge batten with the Anticon's side lap pointed in the direction of the uninsulated roof area. Roll the Anticon away from the ridge batten towards the fascia/gutter.

Note: Use Brad-Fix clips to hold blankets temporarily in position as required.

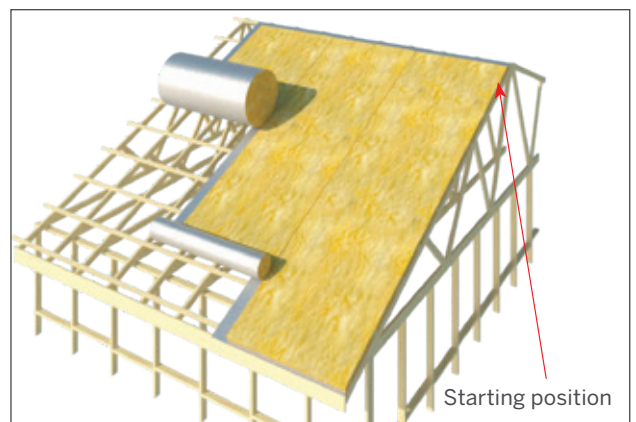

STEP 2

Allow Sag – Gently adjust the Anticon length and width at each crossing of a batten or rafter to allow sufficient blanket sag to recover to its advertised thickness below the roof sheet once in position.

Note: Bulk insulation contact with the metal cladding must be maintained after the sag allowance. Anticon 60 requires 60mm downward sag/Anticon 80 requires 80mm downward sag; between each batten or rafter crossing.

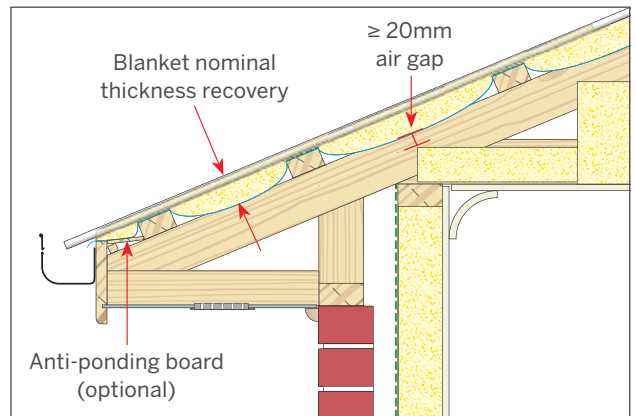

STEP 3

Roll out next blanket – Repeat Step 1 until you reach the end of the roof, then repeat Step 1 from the other side of the roof. Commence from the opposite starting end of the roof. Start roll out from end lap over ridge down to fascia. Ensure that the earlier exposed foil lap ($\geq 150\text{mm}$) is below the adjacent roll and the bulk insulation of both rolls abuts leaving no gaps.

For high risk condensation zones or when a vapour control layer (VCL) is required – use a foil membrane having a vapour barrier classified as Class 1 or 2 as per AS/NZS4200.1. Foil must be lapped and taped at all joints, tears and discontinuities (AS/NZS4200.2).

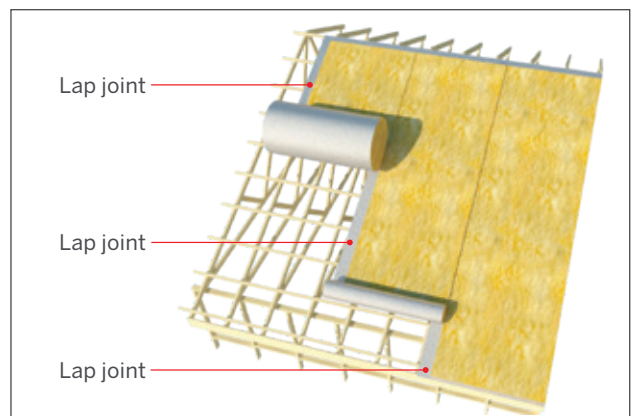

*For applications in tropical climates, use alternatives:

1. Antiglared Anticon installed with bulk insulation side down. Upper foil to be nominated as vapour barrier HIGH foil.
2. Tropical Roofing Blanket, refer to Tropical Roofing Blanket Installation Guidance.

STEP 4

End join – the end and start of a new blanket must be overlapped by 1 x batten crossings. Remove bulk insulation from the lower portion of the roll width. Trim and peel away the bulk insulation from Blanket B that crosses the batten, exposing the RFL. Allow upper Blanket A to abut the lower blanket's bulk insulation, position over Blanket B's exposed facing.

Note: Limit blanket B's foil 'overhang' to present neat appearance when viewed from below.

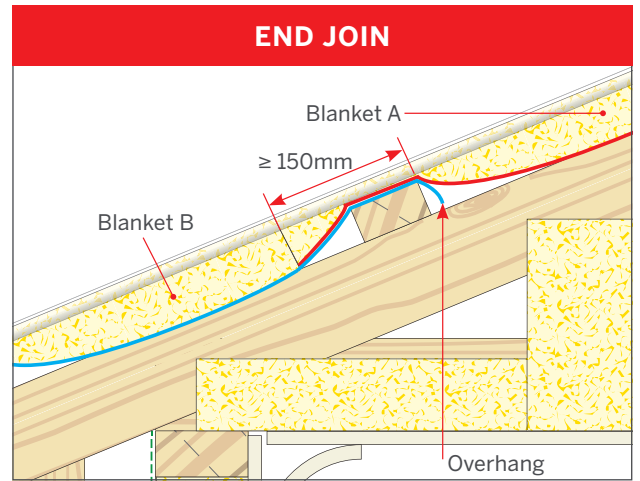

STEP 5

Side lap joints – lap joints are recommended to have a $\geq 150\text{mm}$ foil overlap, or alternatively tape lap joints.

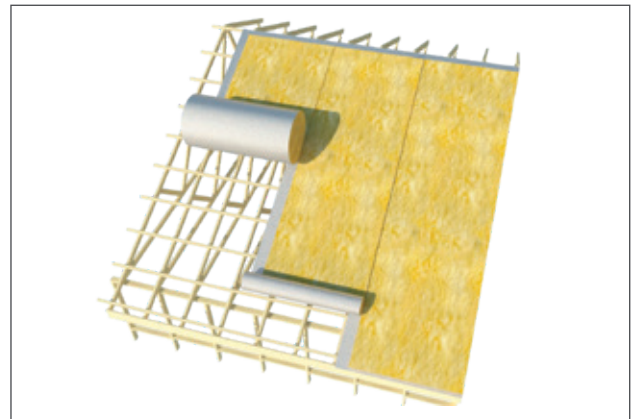

STEP 6

Ridge Line Join – When starting to lay Anticon from the other side of a ridge, the Anticon must be extended over the ridge and abut an existing Anticon on the other side (existing from Step 1 to 5).

Ensure the RFL portion of the blanket extends at least 150mm crossing over a batten. Peel 150mm of bulk insulation from existing blanket and trim off. RFL edges must be lapped in a cascading manner whilst ensuring bulk insulation abuts.

Ridge Line Join and Ridge Line Venting are both suitable methods for BAL (Bushfire Attack Level) applications. Where a specifically designed ridge ventilation is installed, the blanket must be terminated at the ventilation.

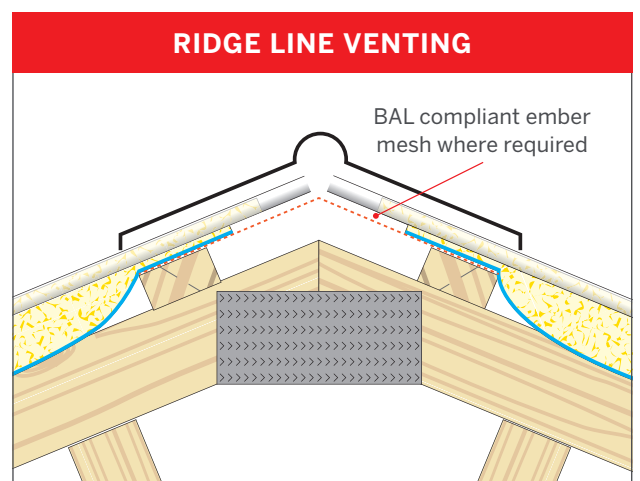
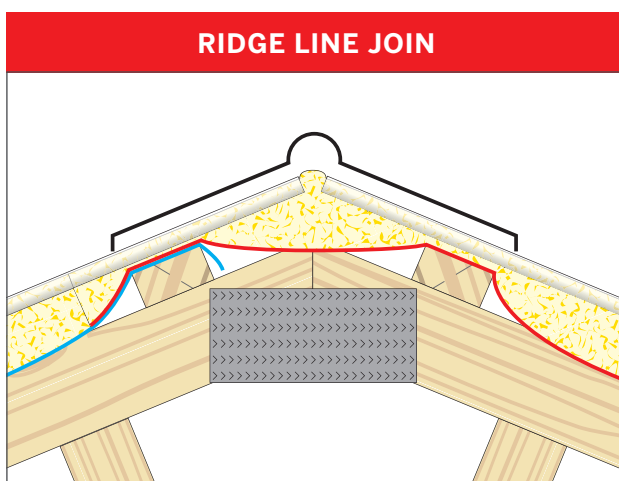

STEP 7

Roof cladding – to be installed in accordance with roof manufacturer's instructions.

Treatment of Common Roofing Elements

The following steps are general guidelines for treatment of common roofing elements. Alternative methods may also be used to address these elements. For additional details, please contact your Bradford representative.

FASCIA AND GUTTER

It is recommended that the Anticon is trimmed flush at the edge of the external side of the fascia. This location is where the cladding will pinch the Anticon down onto the fascia top edge and close off the corrugated profile openings. This will provide compliance to BAL (Bushfire Attack Level) requirements for ember protection.

Note: If the Anticon is too long and allowed to drape into the gutter, rain/moisture may be drawn back onto the bulk insulation in the roof cavity. This may cause corrosion to the cladding and damage to the roof structure – this will void the product warranty.

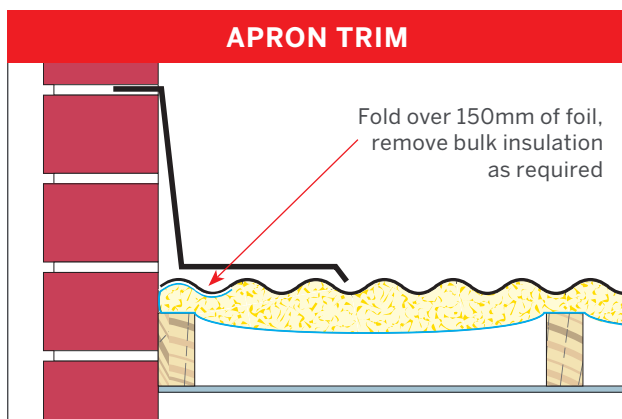
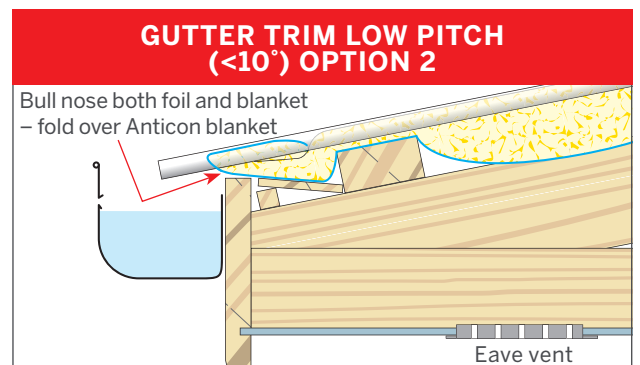
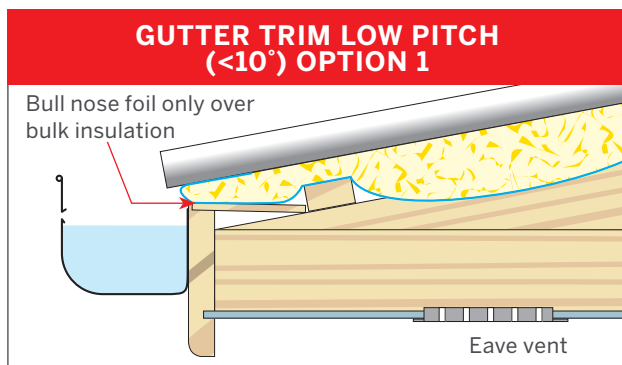
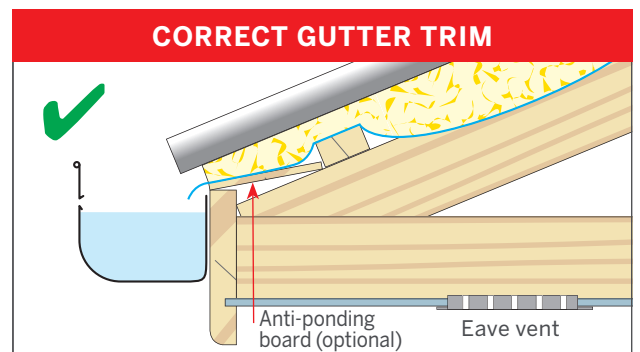
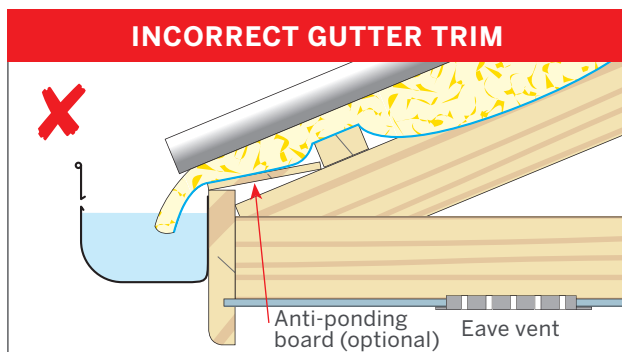

VALLEYS

Similarly to step 5, ensure that any excess of blanket material that abuts the valley flashing is trimmed back to reduce the risk of the bulk insulation edge coming into contact with the valley water path.

It is an acceptable practice to peel bulk insulation and fold back away from the flashing whilst leaving RFL folded back at the flashing edge ensuring it is not in the water way.

Note: Refer to gutter trim low pitch option 1 for fold details.

TEARS AND PENETRATIONS

Tears and/or penetrations are recommended to be sealed using Bradford foil tape (or approved equivalent) applied to the underside of the foil.

TAPES

Ensure Tapes are non-shrink, approved contact pressure sensitive, heat and moisture resistant, adhesive tape (such as PPC 493 72mm wide tape) applied in accordance with the manufacturer's instructions. Tape sealing from above when access is limited from below requires additional cleaning of the RFL surface, and additional pressure to apply double sided tape. A base board can be used to provide support when applying tape.

HOT FLUE PENETRATIONS

Tapes are not suitable to be adhered around hot flues. Leave at least 50mm clearance between the Anticon blanket and any hot surface.

COLD REGIONS

For applications in cold regions, or those buildings having high indoor humidity requiring a vapour barrier control layer, all lap joints are recommended to be sealed using a double sided tape applied to seal overlaps or foil tape applied to the underside of the RFL.

VENTILATOR INSTALLATION

At the location where the roof ventilator will be installed, cut Anticon to suit vent opening to allow air movement. Cut an X in the Anticon the same diameter as the throat of the roof ventilator. Fold back the sections of Anticon and seal using Bradford foil tape or approved equivalent.

Notes:

CSR Bradford makes every effort to ensure the information in this document is correct and current at time of issue but it is the responsibility of the user of this document to ensure that the design calculations and products selected are suitable for the application and meet all regulatory requirements.

1. Reflective foil sarking surfaces are required to have a minimum non-ventilated air space of not less than 20mm in order to create a level of thermal performance from the still air adjacent to the foil surface.
2. Performance claims may vary depending upon bulk insulation recovery thickness, roof pitch angle, ventilation of roof cavity and dimension of air cavity adjacent to the reflective foil surface.
3. For cold climate zones 7 and 8 optimum condensation control is provided when all joins and discontinuities, overlaps, penetrations, and tears are sealed by means of duo tape within the lap joint and/or foil lap joint taping. For more information on cold climate solutions, please contact CSR Bradford.
4. For Bushfire BAL 12.5 to 40, and FZ regions – Bradford Anticon range meets the BAL requirement for metal clad roofs in bushfire areas. Refer to the Bradford Bushfire Roofing Systems design guide or contact the Bradford Technical Office to ensure your Anticon installation is compliant with relevant standards.
5. Failure to keep Anticon dry may lead to breach of Product Warranty.
6. Alternative edge protection to product ends exposed to weather – fold product thickness back on itself to form a bull nose end. If the doubling of product thickness impinges on cladding installation, fold back only RFL approximately 150mm.
7. Where required, cleaning of RFL surface can be done using a clean cloth dampened with methylated spirits solution.

8. CSR Bradford Anticon is manufactured with an RFL that is electrically conductive – care must be taken when installing Anticon in the proximity of electric wiring and lighting fixtures – always consult a qualified electrician if unsure.
9. A control layer in an enclosure, assembly or element that provides a level of control to the passage of air, liquid, heat or vapour.

Vapour Control Layer (VCL) is used to restrict moisture found in the air to one side of the building's wall or floor or roof/ceiling construction, to provide a Class 1 or 2 (as per AS/NZS4200.2) water vapour resistance when measured to AS/NZS4200.1. The objective is to maintain the moist air to the warm side of the building so its temperature remains above the dew point of the air it isolates, preventing condensation and consequential damage caused by condensation. For cold climates, VCL are located nearest to the inner wall surface. In tropical climates it is located nearest to the external cladding surface.

Air Control Layer (ACL) is used to provide a Class 1 or 2 (as per AS/NZS4200.2) level of air tightness given a specific wind pressure for a timed duration and reported as XYZ m³/m²/hr @50Pa. Generally, an ACL provides 100% draught tightness to control convection air movement and those air movements resulting from pressure differentials. External wind can provide pressure differentials that can lead to air leaking into or out of the building resulting in heat loss or gains and inefficiencies in a building's energy rating. Draughts can also carry contaminants such as dust and moisture, which can result in condensation (refer to VCL). ACL can be either vapour permeable (vapour open) or vapour barriers (vapour closed).

Water Control Layer (WCL) is used to act as a rain barrier (in the event the roof sheet leaks), or in some cases a condensation collection layer, to provide a Class 1 or 2 (as per AS/NZS4200.2) level of water hold out even after long term water exposure. It prevents the passage of liquid through the WCL and the design must include a means for the water to flow away using a path to drain/discharge the liquid to a suitable area such as a gutter. The design of a drainage path can sometimes double as a venting path to dry the drainage passage way. WCL can be vapour barrier or vapour permeable membranes that can be ACL or not ACL.

VCL, ACL and WCL must be continuous and any joints, tears, or penetrations must be lapped (cascading manner for WCL) and taped to maintain a Class 1 or 2 (as per AS/NZS4200.2) vapour/air/water resistance and reach the extremity of the building

For further information call **1300 850 305** or visit **bradfordinsulation.com.au**



CSR Bradford Locked Bag 1345 North Ryde BC NSW 1670
bradfordinsulation.com.au



CSR Bradford is a business division of CSR Building Products Limited ABN 55 008 631 356.

The contents of this brochure are copyright protected and may not be reproduced in any form without prior written consent of CSR Bradford. Recommendations and advice regarding the use of the products described in this brochure are to be taken as a guide only, and are given without liability on the part of the company or its employees. We reserve the right to change product specifications without prior notification, please refer to the CSR Bradford website for the latest revision of this document prior to use. The purchaser should independently determine the suitability of the product for the intended use and application.

